

User manual

HDN

USER MANUAL – HDN – EN VERSION 03.02

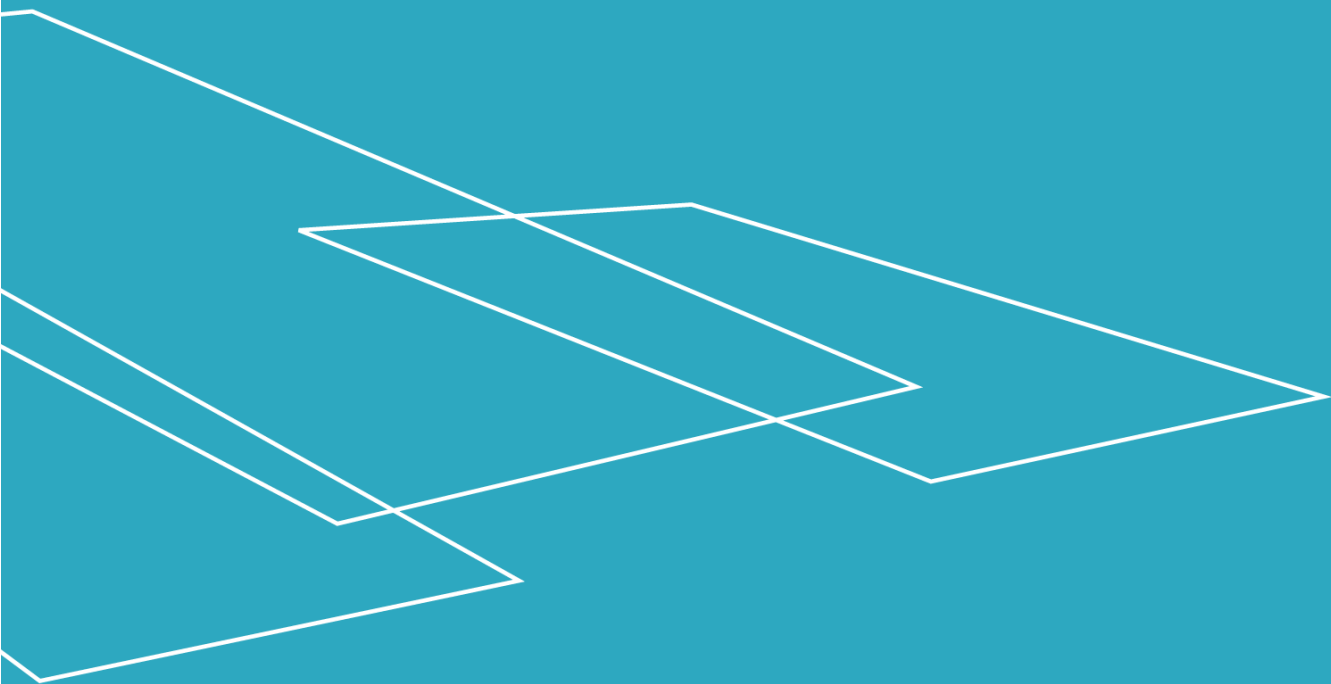



## Table of contents

1. Foreword.....	4
2. EU Declaration of Conformity.....	5
3. Factory Acceptance Test (FAT).....	6
4. Terms of use.....	7
5. Technical specifications.....	8
6. Safety instructions.....	9
6.1 Installation and maintenance .....	9
6.2 Unintended movements of the lift.....	9
6.3 Operating conditions .....	9
6.4 Overloading the lift.....	9
6.5 Personal safety .....	9
6.6 Anti-crushing.....	10
6.7 Avoid personal injury .....	10
6.8 Safety barriers.....	10
6.9 Automatic door.....	11
6.10 Unlocking the door in an emergency.....	11
6.11 Emergency evacuation in the event of a malfunction.....	11
6.12 Handling.....	11
7. Function description.....	12
8. Assembly .....	12
9. Start-up.....	12
10. Operation.....	13
10.1 Everyday use.....	13
10.2 Operation of the HDN lift from UPPER level.....	13
10.3 Operation of the HDN lift from LOWER level .....	13
10.4 Operating the HDN lift when the user is on the lift .....	14
10.5 Emergency stop .....	14
10.6 Key switch .....	14
11. Operation.....	14
12. Maintenance.....	15
12.1 Cleaning.....	15
12.2 Mechanical maintenance.....	15
12.3 Replacement of battery in call stations/remote control .....	15
13. Pairing transmitter and receiver .....	17





13.1 Wireless call station/call station column 2.4 GHz ..... 17

13.2 Remote control 2.4 GHz ..... 19

14. Installation and handover.....21

15. Inspection, checks and service inspections .....22

    15.1 Statutory inspection and checks.....22

    15.2 Regular service inspections.....22

    15.3 Service report for use in service inspections .....23

    15.4 Service log book.....24

    15.5 Online service log (only certain countries) .....25

16. Spare parts and accessories .....26

17. Disassembly .....26

18. Disposal .....26

19. Warranty .....26

June 2023

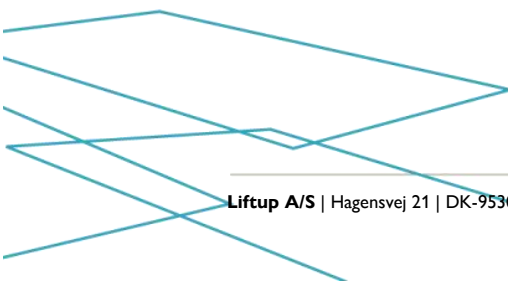



## 1. Foreword

Congratulations on purchasing your new wheelchair lifting platform. This is an original user manual for your new lift.



**It is important that you read the entire manual before using the lift**

Set-up and installation **MUST** be carried out by an authorised service technician in order to ensure correct assembly. Incorrect assembly could cause a risk of personal injury.

The HDN lift is an innovative lift for wheelchair users. The solution combines an elegant design with a robust construction that can be adapted to the lift's surroundings. The lift has a space-saving design and does not require space for long ramps etc. The floor is raised and lowered easily and elegantly, which allows wheelchair users and those with impaired mobility quick and easy access between two levels.

The HDN lift is operated easily by means of operating panels mounted on the wall, a call station column positioned on the lift and/or by means of an elegant remote control (optional equipment).

**In this manual, the “HDN lift” is referred to as the “lift”.**

Where an “authorised service technician” is referred to below, this refers to a service technician who has completed a product and service course at Liftup.



## 2. EU Declaration of Conformity

**Manufacturer:** Liftup A/S  
**Address:** Hagensvej 21, DK-9530 Støvring, Denmark  
**Telephone:** +45 9686 3020



hereby declares that:

**Equipment:** **HDN lift**  
 Hidden and lowerable lift for wheelchair users and persons with impaired mobility

**Year:** **2012**

The equipment complies with important requirements in the CE Marking Directives:

The Machinery Directive: 2006/42/EC  
 The Electromagnetic Compatibility Directive (EMC): 2014/30/EU  
 Restriction on Hazardous Substances (RoHS): 2011/65/EU  
 The Radio Equipment Directive (RED): 2014/53/EU

The equipment complies with requirements based on the following standards:

ISO 9386-1:2000 Power-operated lifting platforms for persons with impaired mobility  
 DS/ EN 60204-1 Electrical Equipment on Machines

CEO	Søren Elisiussen
_____	_____
<b>Position</b>	<b>Name</b>
Liftup A/S, Hagensvej 21, DK-9530 Støvring, Denmark	
_____	
<b>Location</b>	
1 February 2021	
_____	_____
<b>Date</b>	<b>Signature</b>



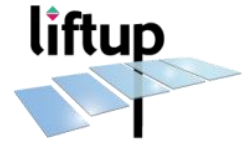

### 3. Factory Acceptance Test (FAT)



TÜV ISO 9001:2015  
 Certified Management System

## FACTORY ACCEPTANCE TEST

# Certificate

**is hereby issued to HDN lift with serial no.**

*(insert serial number / copy of CE certification mark here)*

**The validity of the CE certificate is subject to correctly performed installation, cf. the manufacturer's instructions.**

**To certify that all safety tests, performance tests and other tests specified by our certified ISO 9001:2015 Quality Management System have been successfully passed and documented.**



---

Issue date

---

Test responsible

---

Liftup A/S | Hagensvej 21 | 9530 Støvring | Denmark  
 T: +45 96 86 30 20 | M: mail@liftup.dk  
 www.liftup.dk | CVR: DK-1015 3964

---





## 4. Terms of use

The HDN lift is exclusively for the use of wheelchair users and persons with impaired mobility. The maximum load is 400 kg, evenly distributed on the lift (max. 2 persons). The maximum load can also be seen on the CE mark fitted on the inside of the plates.



**This user manual must be read through thoroughly before the lift is put into operation**



**IMPORTANT!** The lift must NOT be used to transport goods, and pallets containing goods or any other form of heavy load must not be put onto it.



**IMPORTANT!** The owner of the lift is obliged to maintain it in accordance with the maintenance instructions in section 12.



Do not dispose of batteries or electrical and electronic equipment together with unsorted household waste. When disposing of batteries, local provisions and regulations must be complied with.



**Max 400 kg**  
**Max 880 lbs**

The maximum load is 400 kg, **evenly distributed on the lift** (max. 2 persons).

The owner is obliged to ensure that statutory inspections, checks and service inspections are performed at the correct intervals, see section 15, and that the necessary safety equipment is available.



## 5. Technical specifications

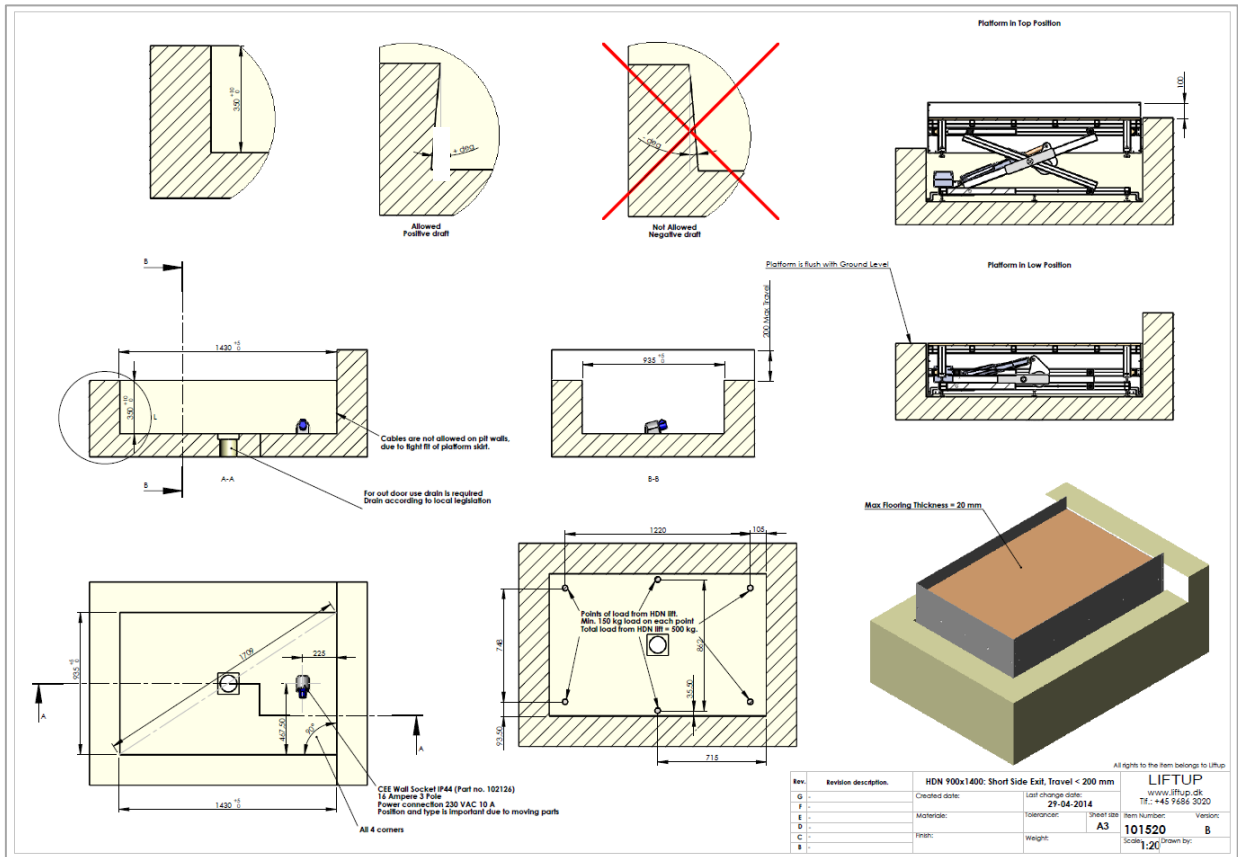

### Specifications:

Power supply:	230 V/50 Hz/min. 10A
Platform size:	1400 x 900/1000/1100 mm
Unladen weight:	approx. 110 kg
Pit depth:	350 mm
Lift height:	0 – 500 mm
Lift capacity:	400 kg
Lift speed:	20 mm/sec.
Noise level:	< 70 dB
Approval:	The Machinery Directive 2006/42/EC
Operating cycle:	2 mins /18 min.
Ambient temperature:	-25 °C to +65 °C
Full capacity:	+5 °C to +40 °C





## 6. Safety instructions

### 6.1 Installation and maintenance

Do not attempt to install or repair your HDN lift yourself. This **MUST** be done by an authorised service technician. Do **NOT** remove safety plates or top plate, as this could lead to the lift causing personal injury.

### 6.2 Unintended movements of the lift

If, while using the HDN lift, actions or movements not described in this manual occur, the unit must be brought to a stop and technical assistance called for.

If the lift does not move on a true horizontal plane as a platform, a mechanical defect may have occurred. In this case, summon technical assistance.

If the lift does not stop at the top and bottom levels flush with the floors, the unit may need to be calibrated. This is done by moving the platform down to floor level and holding down the down button for approx. 5 seconds. If the problem continues, summon technical assistance.

### 6.3 Operating conditions

The space under the lift must be kept free of all items/objects that could prevent the lift moving in a downward direction. Otherwise, the lift cannot be moved to the lowest level and cannot therefore be used as a wheelchair lift. In normal circumstances, no items/objects will be able to get under the lift as access to this area is completely sealed off. If an item/object nevertheless prevents the lift from moving in a downward direction, the anti-crushing safety feature will be activated (see section 6.6).

### 6.4 Overloading the lift

In order to avoid material damage or injury in connection with overloading (max. 400 kg, evenly distributed on the lift), the HDN lift is equipped with overload protection that stops the lift in the event of overloading. In the event of overloading, move the lift downward to exit.

### 6.5 Personal safety

The HDN lift is equipped with various safety devices that ensure that the user and other persons do not come to harm when using the lift.



#### **WARNING!**

Although the lift is equipped with various safety devices, never use the HDN lift if there are persons or animals in the vicinity, so as to avoid any risk of crushing. **Never allow children to play with or on the lift.**

### 6.6 Anti-crushing

The HDN lift is fitted with safety plates on all open sides in order to protect people from crushing. These plates must not be removed as this could lead to personal injury.



**NOTE:**

The plates also act as safety barriers, i.e., when the lift is moving up, the plates will first move up 100 mm before the lift begins to move.

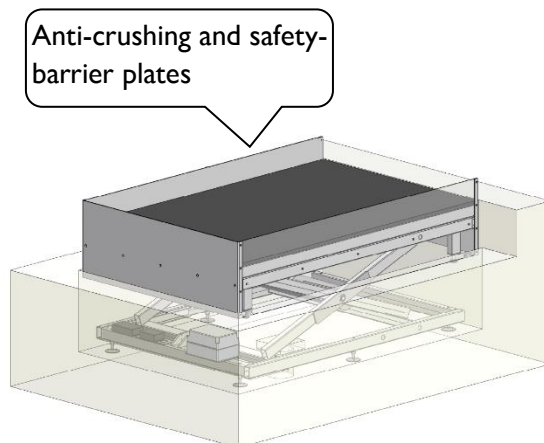

### 6.7 Avoid personal injury

In order to avoid personal injury, it is NOT permitted to use the HDN lift when anyone or anything is in danger of being injured or damaged as a result of crushing, cutting, falling, tripping etc.

It is important for the user/operator to ensure that the lift can move without putting anyone or anything in danger.

Be extra careful when small children, elderly people or disabled people are on or in the vicinity of the lift, as these groups cannot always be expected to be able to foresee the potential consequences of the movements of the lift. Never attempt to load more onto the lift than the maximum load (400 kg) stated on the load sign.

### 6.8 Safety barriers

The safety plates will be raised and lock before the lift begins to operate. The safety plates will now act as safety barriers.

When the lift moves down, the safety plates will automatically move down into the lift and the lift can subsequently be exited.



*Level floor,  
ready to enter/exit*



*Safety plates  
in up position*



*Lift on upper level,  
ready to enter/exit*

## 6.9 Automatic door

If the lift is supplied with an automatic door (optional equipment), this will close before the lift begins to move. The door will always be closed when the lift is away from the upper level.

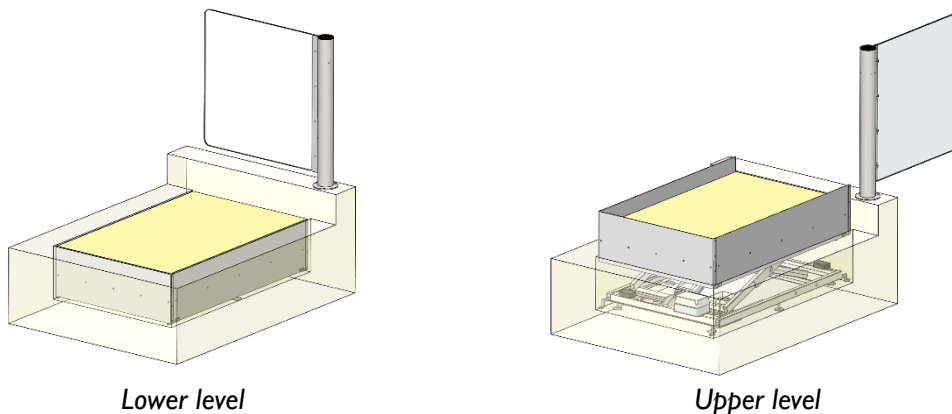

## 6.10 Unlocking the door in an emergency

In an emergency/breakdown: Remove the glass.

## 6.11 Emergency evacuation in the event of a malfunction

In the event of a (serious) fault where the lift has shut down, only a service technician can make the lift move. It is not possible to lower it manually. By virtue of the low lift height (max. 500 mm), the user must be helped out of the lift manually in such an event. If a user needs to be lifted out of the lift (e.g., a wheelchair user) suitable lifting equipment/aids should be used.

## 6.12 Handling

The lift will normally be delivered by a dealer, who will also be responsible for the installation. Do not attempt to move the lift manually as this could lead to personal injury. The product must be moved and handled using lifting equipment that is suitable for the purpose (pallet lifters, roller plates etc.).

The lift must not be subjected to strong impacts/bumps, as this could affect its functionality.

The accompanying remote control (optional equipment) must be stored in a dry place and not be subjected to strong impacts. It must only be cleaned using a cloth that has been wrung out. Never use a high-pressure washer or water hose to wash down the lift as this could cause defects in the product.



## 7. Function description

The lift is a so-called “dead man’s switch” lift, i.e., the push buttons must be depressed during the entire operation.

The lift is easy to operate: The user summons the lift using one of the buttons on the wall or the accompanying remote control (optional equipment). When the user is on the lift, it is operated from the panel at the lift, from where transport to the higher or lower level is selected.

## 8. Assembly

The lift is installed by an authorised service technician. Do not attempt to uninstall the HDN lift or repair it. This **MUST** be done by an authorised service technician.

In the event of incorrect assembly, there may be a safety risk for users. Liftup is exempt from any liability if assembly and installation are not performed by an authorised service technician.

For further information or material regarding assembly, please contact your agent:

<https://www.liftup.dk/en/distributors/>.



**In Denmark**, the Working Environment Authority has introduced new rules for owners/users of lifts, lift products etc. with effect from 30 June 2016. (Danish Working Environment Authority Order No. 461 of 23 May 2016). This is of importance with regard to the number of preventive maintenance inspections and statutory installation checks the product requires. In order to quality assure these inspections, Liftup has developed and implemented an online service log that is available for all our products. In future, all inspections and checks must be recorded in this log (find out more about the equipment’s online service log in section 15.5).

## 9. Start-up

The HDN lift must always be connected to a 230 V socket and be switched on. Normally, the lift is always in “standby mode”, i.e., it is ready for use as soon as one of the operation keys is pressed.

## 10. Operation

### 10.1 Everyday use

The HDN lift is operated by means of the two operating panels, above and below the lift respectively, a call station column positioned on or beside the lift and/or the remote control (optional equipment). The remote control replaces or supplements the fixed button panels.



Operating panel:  
Summon lift - up or down

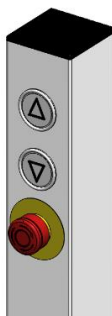

Call station column



Remote control  
(optional equipment)

### 10.2 Operation of the HDN lift from UPPER level



The HDN lift ready for operation  
at the upper level

The HDN lift is summoned to the UPPER level by pressing the arrow button (▲). Continue to press on the button until the lift has travelled all the way up, at which point the lift will stop automatically when the button is released.

First, the lift will raise the safety plates up, after which it will move up to the upper level. The lift stops automatically when it reaches the upper level. After this the wheelchair can enter the lift.

### 10.3 Operation of the HDN lift from LOWER level



The HDN lift ready for operation  
at the lower level

The HDN lift is summoned to the LOWER level by pressing the arrow button (▼). Continue to press on the button until the lift has travelled all the way down, at which point the lift will stop automatically when the button is released. Once the lower level is reached, the safety plates continue to move down into the lift. Once the safety plates are all the way down and level with the floor, the lift is ready. After this the wheelchair can enter the lift.



### 10.4 Operating the HDN lift when the user is on the lift

The HDN lift operates as a wheelchair lift by means of the arrow buttons (▲/▼) or the remote control (optional equipment).

- To move the lift up, press on the arrow button (▲) and keep pressing it until the lift stops.
- To move the lift down, press on the arrow button (▼) and keep pressing it until the lift stops and the safety plates have moved tall the way to the bottom.

### 10.5 Emergency stop

There must be access to the emergency stop from the lift. The emergency stop can either be located on the call station column or in a box on a nearby wall or column etc. The emergency stop must always be able to be reached from the platform.

If the lift makes an unintended movement, or if the lift needs to be brought to a stop in order to avoid any element of danger, press on the EMERGENCY STOP button. In order to disengage the emergency stop, turn the button clockwise and the system will be ready to use.



Emergency stop



Call station column with emergency stop

### 10.6 Key switch

The lift can be supplied with a key switch (optional equipment) that can turn the lift on and off

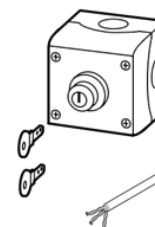

## 11. Operation

In normal operating conditions, the lift should always be connected to 230 V. The lift is in standby mode when not in use and will always be ready for use when required.



#### IMPORTANT!

If you observe the lift not running as expected or stopping again after a few centimetres, technical problems may have arisen that will need to be repaired by technical staff. Contact your agent for further assistance.

## 12. Maintenance

### 12.1 Cleaning

Clean by wiping off with a cloth that has been wrung out in water containing a mild detergent.



#### **IMPORTANT!**

Do NOT use a high-pressure cleaner or wash the lift down with water from a hose. Aggressive detergents and suchlike must not be used on the lift and salt or sand must not be used in connection with winter conditions.

### 12.2 Mechanical maintenance

Mechanical maintenance of the lift must normally be performed in connection with the regular service inspection that is to be carried out by an authorised service technician several times a year depending on whether the lift is installed indoors or outdoors, see section 15.2.

In the event of unintended faults or noises, contact your agent immediately to have the fault repaired.

### 12.3 Replacement of battery in call stations/remote control

A CR2032 battery is installed in the wireless call stations/remote control (optional equipment).



The battery must be replaced every two years to ensure stable operation.



BE SURE not to swallow the button battery and avoid putting the battery in your mouth due to the risk of swallowing it.



Keep the batteries out of the reach of small children. If a child swallows a battery, contact a doctor immediately.



Do not dispose of the battery together with unsorted household waste. When disposing of batteries, local provisions and regulations must be complied with.



## How to replace the battery

### Hand-held remote control

1. Loosen the screw (Torx TX 6) on the rear of the remote control
2. Remove the rear panel
3. Replace the battery
4. Replace the rear panel and test the remote control



### Call station

1. To gain access to the battery, loosen 2 Torx screws and pull the top cover down to separate it from the body.

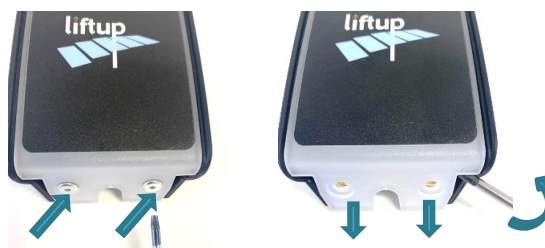

### Call station column

1. To gain access to the battery, loosen the 4 screws and pull up the top cover carefully.



**IMPORTANT!** Be careful not to disconnect the wires from each other. Pull the printed circuit out of the top cover carefully.

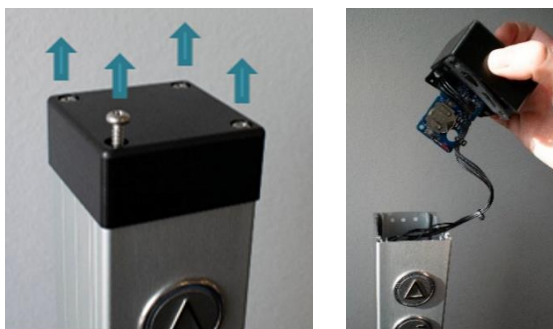

2. Replace the battery
3. Put the unit together in the reverse order and test the buttons.

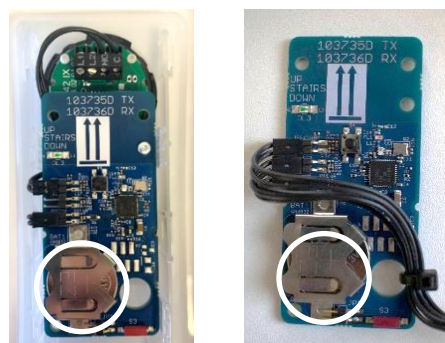

If the remote control or receiver has been without power for a long period of time, it may be necessary to calibrate the system (pair the two units), see section 13.2.

## 13. Pairing transmitter and receiver

### 13.1 Wireless call station/call station column 2.4 GHz

The transmitter and receiver must always be paired in order to work. This is normally done at the factory or by an authorised service technician. The receiver will not respond to a transmitter if it is not paired with. A receiver can be paired with up to 20 transmitters. A transmitter can be connected to several receivers if necessary.

#### How to pair transmitter and receiver:

1. To gain access to the receiver (107500), the top is lifted off of the lift (only a service technician has access to this). Then the cover of the receiver box is removed by loosening the 4 screws.



2. Briefly press on 'Connect' (1). When the control light starts to flash slowly, the receiver is in installation mode for 2 minutes.

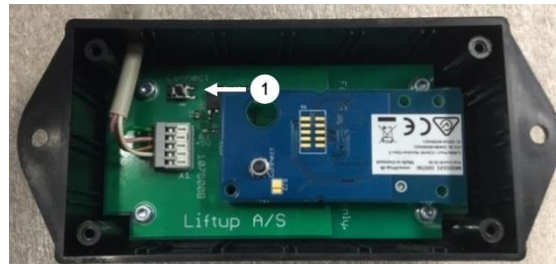

3. Gaining access to the transmitter:

#### Call station

To gain access to the printed circuit containing the transmitter, loosen 2 Torx screws and pull the cover down and outward to separate it from the body.

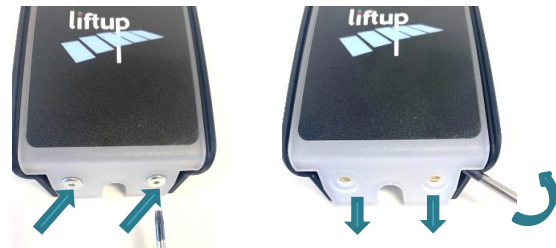

#### Call station column

To gain access to the printed circuit board containing the transmitter, loosen the 4 screws and pull up the top hat carefully.

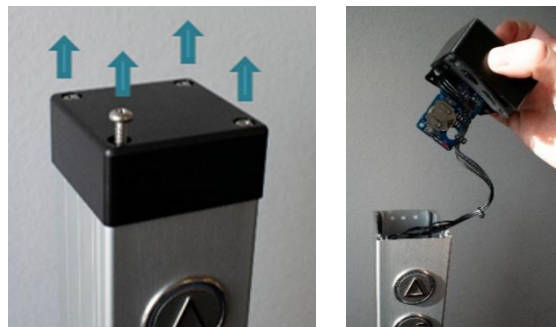

**IMPORTANT!** Be careful not to disconnect the wires from each other. Pull the printed circuit out of the top cover carefully.

- The printed circuit containing the transmitter is now visible and should be briefly pressed at S4 in order to pair it with the receiver (must be done within 2 minutes).

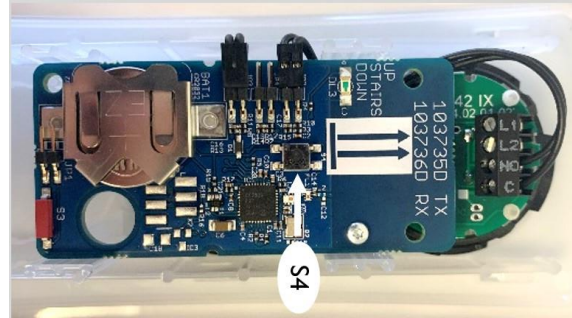

- Test the system to ensure that the pairing has been done correctly; if not, repeat points 1-4.
- If several remote controls are to be paired with the receiver, repeat from step 2 above.

To reset a call station/call station pillar so that it is no longer paired with the lift, the following points should be followed:

**How to reset the transmitter:**

- Press S4 on the transmitter for more than 10 seconds.
- Once the LED starts to flash rapidly, the transmitter has been reset.

**How to reset the receiver:**

- Press Connect (1) on the receiver for more than 10 seconds.
- Once the LED starts to flash rapidly, the receiver has been reset.

### 13.2 Remote control 2.4 GHz

The transmitter and receiver must always be paired in order to work. This is normally done at the factory or by an authorised service technician. The receiver will not respond to a transmitter without it having been paired with the receiver. A receiver can be paired with up to 20 transmitters. A transmitter can be paired with several receivers if necessary.

#### How to pair transmitter and receiver:

1. To gain access to the receiver (107500), the top is lifted off of the lift (only a service technician has access to this). Then the cover of the receiver box is removed by loosening the 4 screws.
2. Briefly press on 'Connect' (1). When the control light starts to flash slowly, the receiver is in installation mode for 2 minutes.
3. Press the 'up arrow' (↑) and 'down arrow' (↓) on the remote control at the same time and hold them down for 5 seconds until the control light on the remote control starts to flash slowly. The remote control is now in installation mode for 2 minutes. It should be flashing yellow. If it flashing red, it is an 868 MHz model and is not suitable for the receiver.

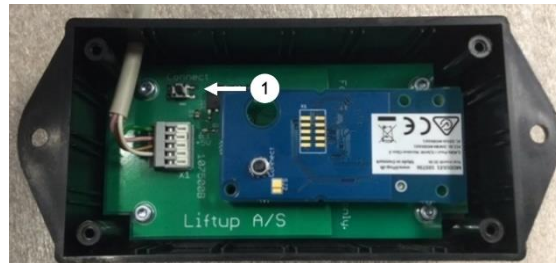

#### Alternatively:

Press on 'Connect' (S4), if the remote control is open.

4. Once the control light on the remote control stops flashing, it has been paired with the lift.
5. Test the system to ensure that the pairing has been performed correctly; if not, repeat 1-3 above. Repeat from step 2 above if several remote controls are to be paired.

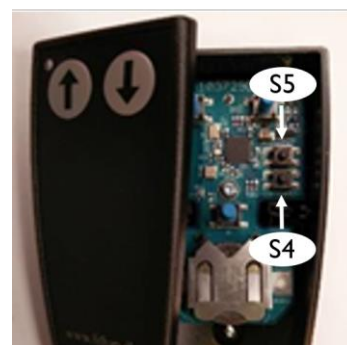

To reset a remote control so that it is no longer paired, the following points should be followed:

#### How to reset the transmitter

1. Press the Up (↑) and DOWN (↓) buttons at the same time for 5 seconds until the control LED on the remote control starts to flash slowly.
2. The remote control is now in installation mode for 2 minutes. The following sequence must be performed within the 2-minute period:

Press: UP(↑), UP(↑), DOWN(↓), DOWN(↓), UP(↑), DOWN(↓), UP(↑), DOWN(↓)

If the sequence is performed correctly, the LED flashes rapidly 10 times.

#### Alternatively:

Press 'Reset' (S5), if the remote control is open.

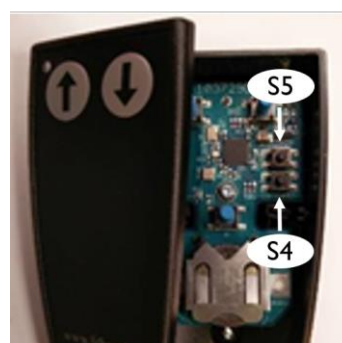

Test the system to ensure that the reset has been done properly and that the remote control is no longer paired. If not, repeat points 1-3 above.

#### How to reset the receiver:

1. Press 'Connect' (1) on the receiver for more than 10 seconds.
2. Once the control light starts to flash rapidly 10 times, the receiver has been reset.

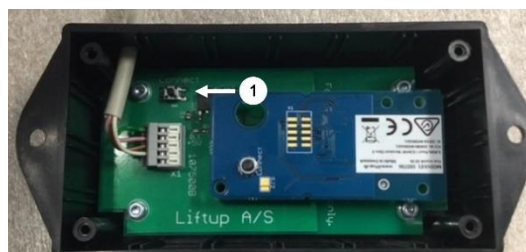





## 14. Installation and handover

The installation and handover check list below, which lists the lift's operating and safety functions, must be gone over with the user/owner of the lift before installation is concluded.



### Installation and handover

---

The form below shall be filled out upon installation.

Client:	Product:
Address:	Product Type No.:
Postcode:	Serial No.:
Telephone No.:	Installation date:
Client acceptance of installation:	Installed by:

**Checklist:**

No.	Description	Checked	Any comments
1	Testing together with the client	<input type="checkbox"/>	
2	Review of the manual	<input type="checkbox"/>	
3	Overload	<input type="checkbox"/>	
4	Safety skirt function	<input type="checkbox"/>	
5	230V to the controls (must not be disconnected)	<input type="checkbox"/>	
6	Any change of the battery in the remote control	<input type="checkbox"/>	
7	Any pairing of the remote control	<input type="checkbox"/>	
8	General maintenance	<input type="checkbox"/>	
9		<input type="checkbox"/>	
10		<input type="checkbox"/>	
11		<input type="checkbox"/>	
12		<input type="checkbox"/>	
13		<input type="checkbox"/>	
14		<input type="checkbox"/>	

Liftup A/S | Hagensvej 21 | DK-9530 Støvring | Denmark | T: +45 96 86 30 20 | M: support@liftup.dk | www.liftup.dk





## 15. Inspection, checks and service inspections

In addition to the general maintenance described in section 12, regular service inspections and statutory inspections and checks of the lift must be carried out.



**IMPORTANT!**

For safety reasons, it is very important that these service inspections and statutory checks are complied with, as a lack of, or incorrectly performed, examinations, checks and inspections could result in personal injury.

### 15.1 Statutory inspection and checks

Statutory inspections and checks of the lift are to be carried out, as it is approved for the transport of people. It is the owner’s responsibility and obligation to ensure that this is complied with.



**IMPORTANT!**

The number of statutory inspections and checks depend on the legislation in the country in question.

A service inspection carried out by a Liftup service technician covers the requirements for the statutory check.

### 15.2 Regular service inspections

As a manufacturer, we lay down requirements for regular service inspections of the lift to be carried out, see the interval stated below.



**IMPORTANT!**

The warranty may become void if the minimum requirement for service inspections is not observed.

**The manufacturer's minimum requirements for number of service inspections (per year)**

	Indoor	Outdoor
Private/not freely accessible	1	2
Public sector	2	4

As a producer, we recommend that the regular service inspections are carried out by an authorised service technician. The agent from whom you have purchased the product will offer this service but, if you wish to use another service provider, it is the owner of the lift who will be responsible for the service technician chosen having received training on the product in question. See also: <https://www.liftup.dk/en/distributors/>.



**IMPORTANT!** The emergency stop must be activated before servicing the lift. This is to protect against accidental operation. The service technician is responsible for the emergency stop being pressed before commencing the service.







### 15.3 Service report for use in service inspections

## Service Report - HDN

Service visit paid for by:  User/installation address     Client/Contractor     Owner/Municipality

Name/company			
Address			
Postcode			
Telephone			
Contact person			
Telephone			
EAN/GLN			

Product	Service level
Product type no	Endnu ingen aftale    Halvårlig
Serial no	
Installation date	Agreed date and time for service visit
Last service date	Agreed about the visit

Other comments:

---



---



---

Service engineer

Checklist

<input type="checkbox"/> Tighten the M10 bolts in the scissor.	<input type="checkbox"/> Load sign.
<input type="checkbox"/> Verify scissor integrity.	<input type="checkbox"/> Check operating units.
<input type="checkbox"/> Audible check of actuator.	<input type="checkbox"/> User manual/instruction at the lift.
<input type="checkbox"/> Load test.	<input type="checkbox"/> Clean the pit.
<input type="checkbox"/> Fixation to the floor.	<input type="checkbox"/> Report in client's service logbook.
<input type="checkbox"/> Verify stability of skirts.	<input type="checkbox"/> Lubrication
<input type="checkbox"/> Check lift, level.	<input type="checkbox"/>

Spare parts installed

Part no.	Qty.	Description	Price per pce.	Price
100455		Actuator cable		
101111		12V batteries		
		Service/inspection		
		Service engineer hours		
		Distance travelled (km)		

Doc. Version: 20220819

---

Liftup A/S | Hagensvej 21 | DK-9530 Støvring | Denmark | T: +45 96 86 30 20 | M: support@liftup.dk | www.liftup.dk





## 15.4 Service logbook

The form (like the example below) must be completed after each inspection.



## Service logbook

---

This form shall be filled in after every inspection. The logbook shall be kept together with the lift.

Client:	Product:
Address:	Product Type No.:
Postcode:	Serial No.:
Telephone No.:	Installation date:
Contact Person:	Telephone No.:

No.	Date:	Comments:	Signature:
1			
2			
3			
4			
5			
6			
7			
8			
9			
10			
12			
13			
14			
15			
16			
17			
18			
19			
20			

Doc version 2023.01.04

---

Liftup A/S | Hagensvej 21 | DK-9530 Støvring | Denmark | T: +45 96 86 30 20 | M: support@liftup.dk | www.liftup.dk





### 15.5 Online service log (only certain countries)

The QR code can be scanned using a smartphone, tablet etc. The QR code is typically, but not necessarily always, mounted on the inside of the plates.



In section 3, a CE mark has been inserted with this specific lift's serial number and QR code with direct access to the lift's online service log. When the QR code is scanned, direct access is given to the lift's online service log and a new log is set up. The fields are filled in and the service technician/installer/regulating authority signs this off electronically in the log after each visit.

Equipment Service Log

**Equipment details**

Serial no. F519-00010

Production year 2019

Equipment type 103141 Flexstep-V2

**Links to more information**

[Link til produktbros](#)

**Equipment log**

These are the recorded service log entries for the equipment.

Log no./IL	Log entry date	Created by	Log entry text	Comments	Signature
1	15/01/2019	PB	Installation/opstilling af lift	Liften er installeret. Intet øvrigt at bemærke ifm. installationen.	PB
2	16/01/2019	Peter Pedersen	Opstillingskontrol	Liften er opstillingskontrolleret iht. bekendtgørelse, uden bemærkninger. Lifte må herefter tages i anvendelse	PP
3	13/02/2020	Hans Jensen	Årlig eftersyn	Årlig eftersyn gennemført iht. serviceaftale med Liftup A/S. Intet øvrigt at bemærke.	HJ

[Add log entry](#)

1. Her kan du se udstyrsdetaljer såsom serienummer, produktionsår med mere.

2. Klik på linket for at se en video om produktet.

3. Det er selve "log-bogen" for udstyret som skal opdateres af service tekniker efter hvert service besøg.

4. Loggen skal udfyldes med dato, navn, en spændt log entry tekst samt relevante kommentarer. Til slut underskrives loggen elektronisk.



## 16. Spare parts and accessories



**IMPORTANT!** It is important to always use original spare parts. Parts must only be replaced by a professionally trained service technician. If non-original spare parts are used, the factory guarantee may become void. Furthermore, the safety of the product may be compromised, leading to the risk of personal injury.

For further information regarding spare parts and services, please contact our agents: <https://www.liftup.dk/en/distributors/>

## 17. Disassembly

In order to ensure the correct disassembly of the lift in order to install it elsewhere, it is recommended that an authorised service technician be used. Contact your agent for assistance with disassembly.

Be aware that a risk of crushing may result from the HDN lift being disengaged from the building and the scissor unit being lifted manually.

## 18. Disposal

The owner is responsible for disposing of the product in accordance with the rules applying at any time. Be particularly aware that batteries are fitted in the control unit and remote control and these need to be disposed of separately.



**IMPORTANT!** Do not throw the batteries into the waste bin. When you dispose of batteries, local provisions and regulations must be complied with.

Where necessary, contact your agent for assistance with disposal.

## 19. Warranty

The warranty applies in relation to the rules applying to the warranty any time.

Liftup offers a full 2-year warranty on spare parts, provided the product has been registered with Liftup (<http://lpr.liftup.dk/>):



## Product Registration

Register your product today and receive 2-years liability for defect on your product directly from Liftup.

Product ID - Serial no.   [?](#)

Type of registrant

First name

Last name

Organization

Address

City

Region / State

Zip Code

Phone

Email

Language

Copy of receipt  Der er ingen fil valgt

If you want to stay updated regarding the latest news and updates, please fill in the check box.

[Register](#)

By registering your information, you agree that Liftup may keep your information in the 2-year period of Liability for defects and contact you upon updated user guides and product safety. When the period of Liability for defects has expired, we will contact you again to ask if we may retain your information. Otherwise they will be deleted. Additionally, this information is used for internal statistics, but is not disclosed to third parties. You can revoke your consent at any time.

For any questions regarding registration or liability for defects please contact [mail@liftup.dk](mailto:mail@liftup.dk).



Find out more about this in our sales and delivery terms, which can be found on our website: <https://www.liftup.dk/en/about-liftup/general-conditions/>.



**NB:**

The warranty may become void if the prescribed service inspections are not observed.

If the prescribed inspections and service inspections are not observed, see section 15, this could have serious consequences for the safety of the product. It is the customer's responsibility to ensure that the product complies with the prescribed inspections and service inspections at all times, see Order No 461 of 23 May 2016, Appendices 2 and 3 and the Danish Working Environment Authority's Order no. 1109, § 14.

**Enjoy your new HDN lift!**

Kind regards  
Liftup A/S

# lifting people

"Aesthetics, design and safety  
are essential in everything we do.  
We are developing dignified aids,  
not machines."

LIFTUP A/S  
Hagensvej 21  
DK-9530 Støvring  
Denmark

+45 9686 3020  
support@liftup.dk  
www.liftup.dk

