

DETAIL A  
SCALE 1 : 10

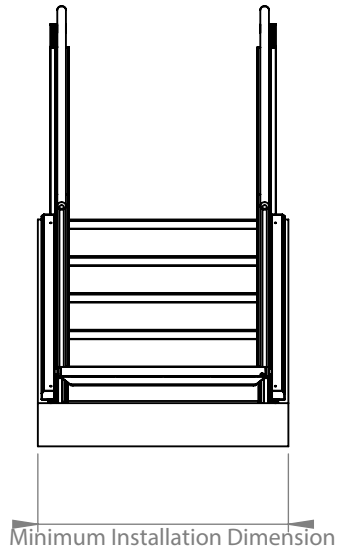

- 1000 mm (model 700 mm)
- 1100 mm (model 800 mm)
- 1200 mm (model 900 mm)
- 1300 mm (model 1000 mm)

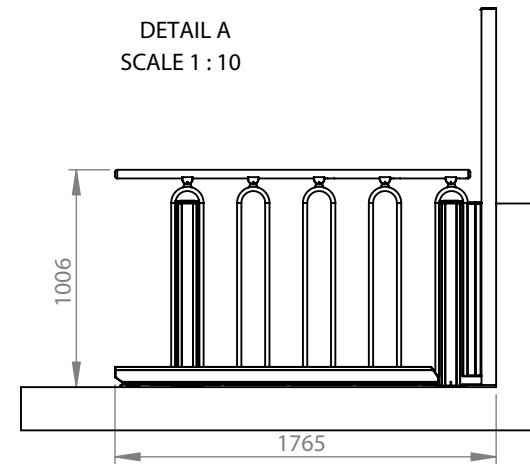
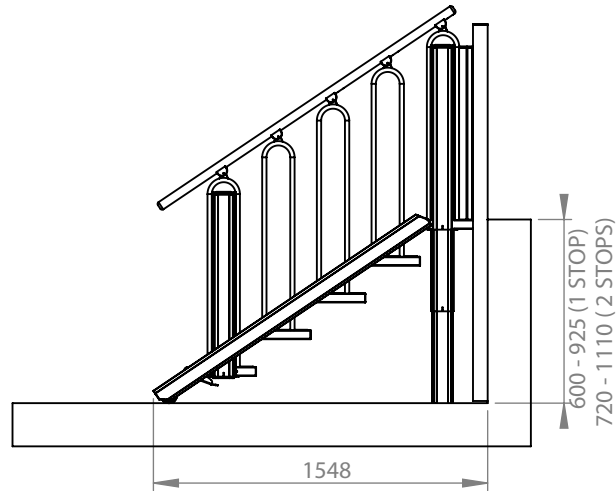

|              |                           |                   |                   |
|--------------|---------------------------|-------------------|-------------------|
| Specs.       | Choice                    | Model:            | 5 STEPS           |
| Installation | Indoor                    | Balustrade:       | Last change date: |
| Handrails    | Oak                       | Round             | 23-03-2018        |
| Step Inserts | Oak                       | Lifting Capacity: |                   |
| Colour       | Akzo Nobel 900            | 400 kg            |                   |
| Packing      | Carton or Wood Pallet Box | Drawn by:         | Customer :        |
| Op. Panel    |                           | MP                |                   |



Product Name  
**FLEXSTEP V2**

Scale: 1:35 A4

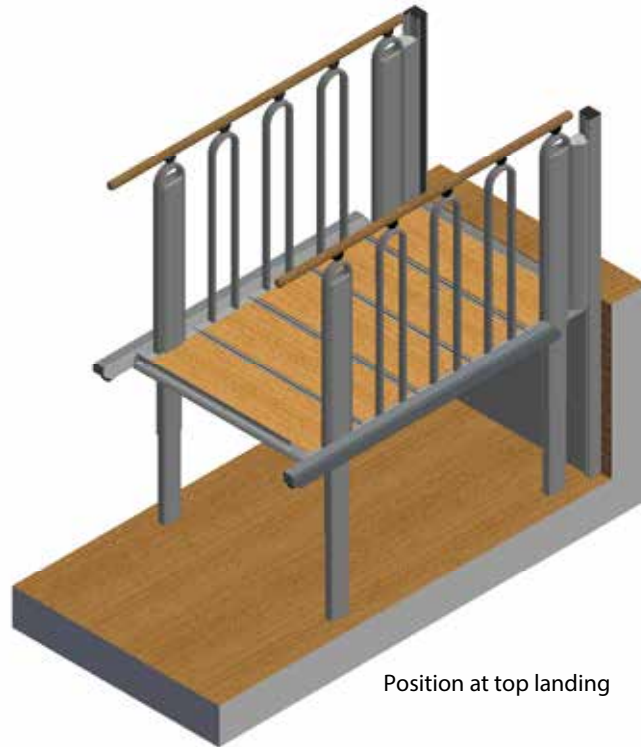

Position at top landing

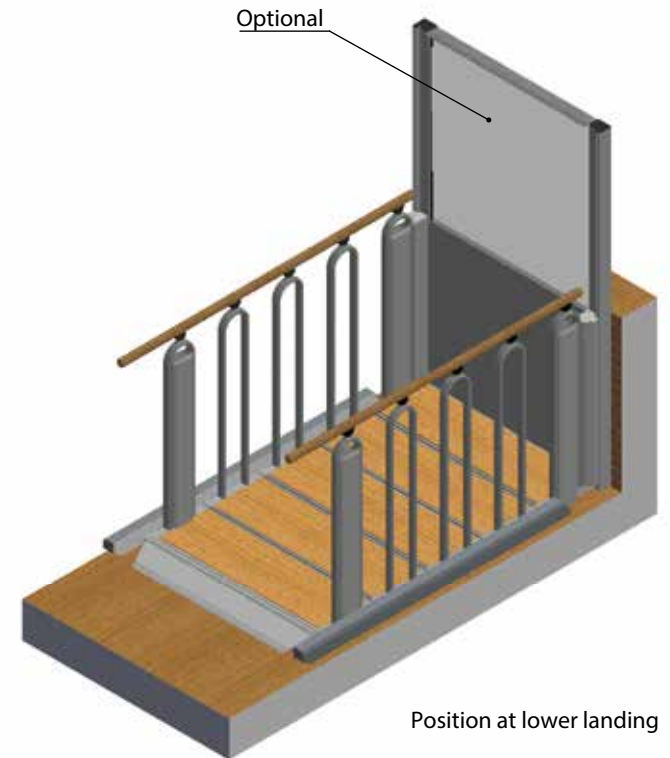

Position at lower landing



Staircase

|              |                           |                   |         |                                 |   |
|--------------|---------------------------|-------------------|---------|---------------------------------|---|
| Specs.       | Choice                    | Model:            | 5 STEPS |                                 |  |
| Installation | Indoor                    | Balustrade:       | Round   | Last change date:<br>23-03-2018 |   |
| Handrails    | Oak                       | Lifting Capacity: | 400 kg  | Customer :                      | Product Name  |
| Step Inserts | Oak                       | Drawn by:         | MP      |                                 | FLEXSTEP V2   |
| Colour       | Akzo Nobel 900            |                   |         |                                 | Scale: 1:30 A4  |
| Packing      | Carton or Wood Pallet Box |                   |         |                                 |   |
| Op. Panel    |                           |                   |         |                                 |   |

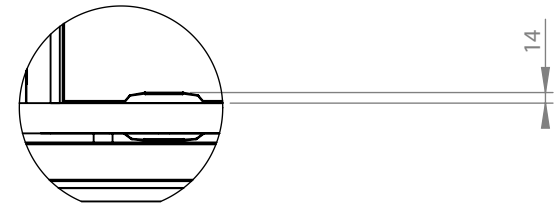
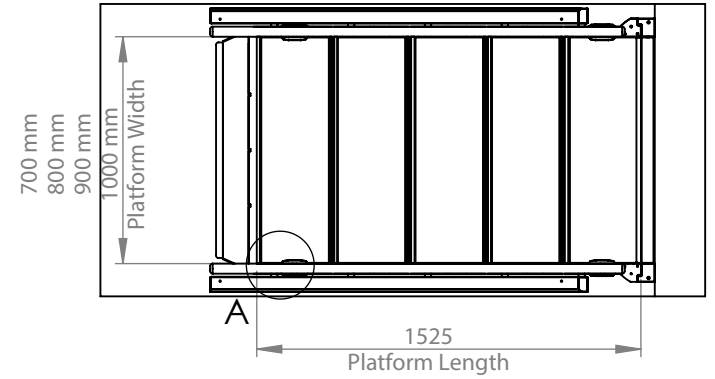
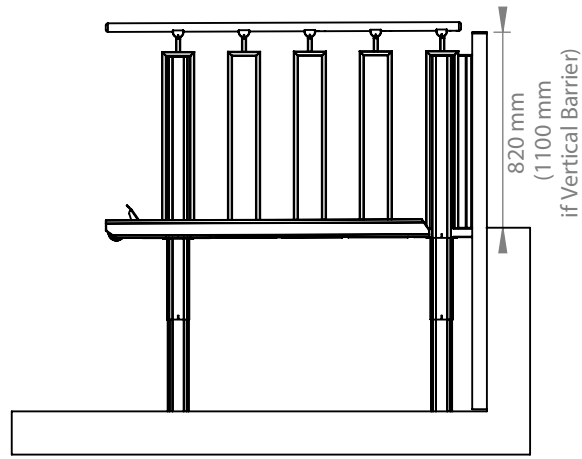
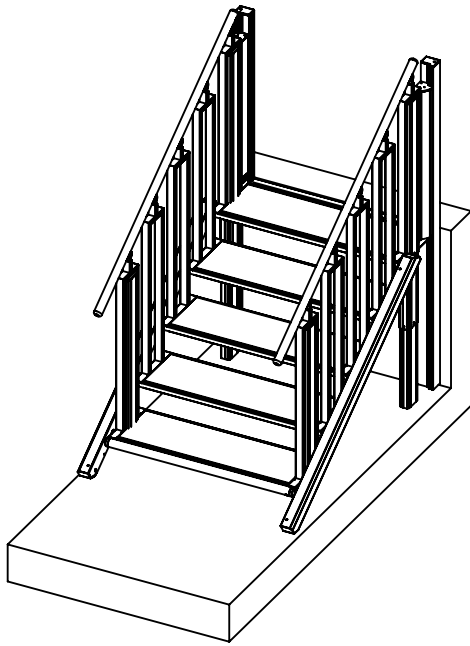

DETAIL A  
SCALE 1 : 10

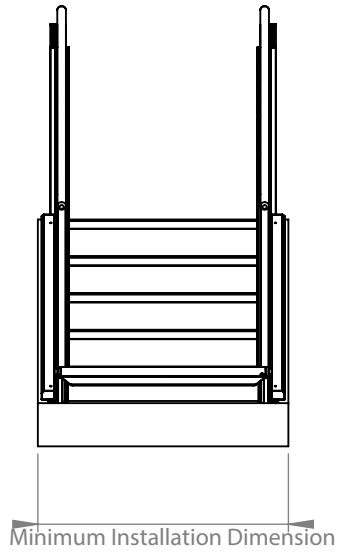
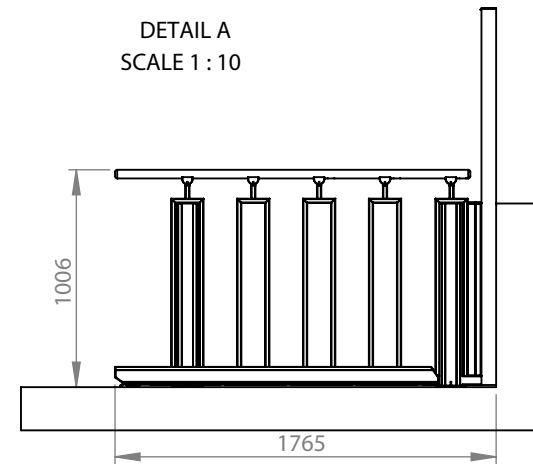

Minimum Installation Dimension  
 1000 mm (model 700 mm)  
 1100 mm (model 800 mm)  
 1200 mm (model 900 mm)  
 1300 mm (model 1000 mm)

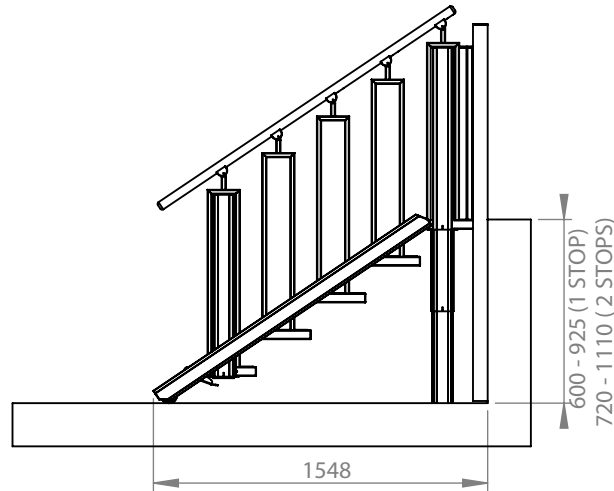

|              |                           |                   |         |                                 |
|--------------|---------------------------|-------------------|---------|---------------------------------|
| Specs.       | Choice                    | Model:            | 5 STEPS |                                 |
| Installation | Indoor                    | Balustrade:       | Square  | Last change date:<br>23-03-2018 |
| Handrails    | Oak                       | Lifting Capacity: | 400 kg  | Customer :                      |
| Step Inserts | Oak                       | Drawn by:         | MP      |                                 |
| Colour       | Akzo Nobel 900            |                   |         |                                 |
| Packing      | Carton or Wood Pallet Box |                   |         |                                 |
| Op. Panel    |                           |                   |         |                                 |



Product Name  
**FLEXSTEP V2**

Scale: 1:35 A4

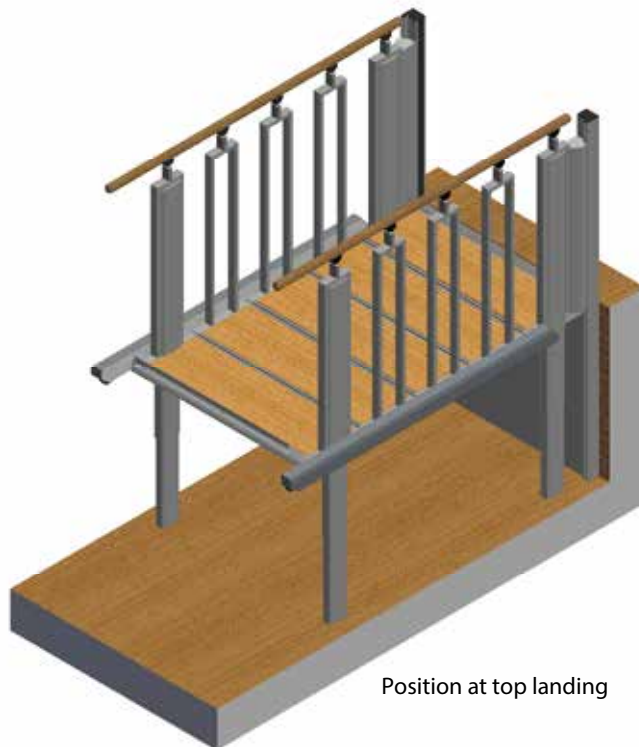

Position at top landing

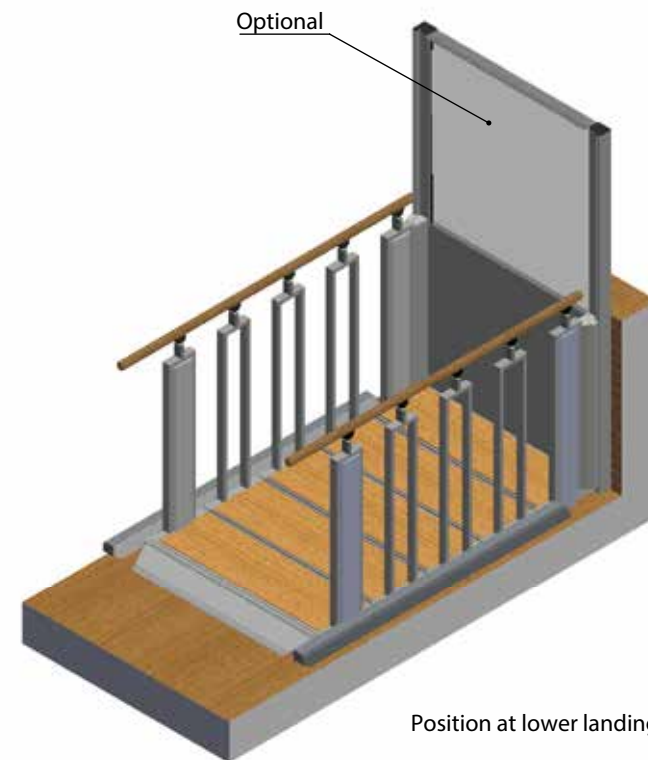

Position at lower landing



Staircase

|              |                           |                   |         |                                 |   |
|--------------|---------------------------|-------------------|---------|---------------------------------|---|
| Specs.       | Choice                    | Model:            | 5 STEPS |                                 | <br>Product Name<br><b>FLEXSTEP V2</b> |
| Installation | Indoor                    | Balustrade:       | Square  | Last change date:<br>23-03-2018 |   |
| Handrails    | Oak                       | Lifting Capacity: | 400 kg  | Customer :                      | Scale: 1:30 A4  |
| Step Inserts | Oak                       | Drawn by:         | MP      |                                 |   |
| Colour       | Akzo Nobel 900            |                   |         |                                 |   |
| Packing      | Carton or Wood Pallet Box |                   |         |                                 |   |
| Op. Panel    |                           |                   |         |                                 |   |